

Operational Manual

3iCube

USB3.0 CMOS cameras

3iCube



Please note that all data and illustrations are subject to error, change and omissions without notice.

Table of Contents

TABLE OF CONTENTS	2
LIST OF FIGURES	5
LIST OF TABLES	6
GENERAL INFORMATION	7
SCOPE OF THE MANUAL	7
RELATED DOCUMENTS	7
OVERVIEW	7
SCOPE OF DELIVERY	8
CONTENT	8
OPTIONS	8
OPTIONALLY AVAILABLE HARDWARE ACCESSORIES	8
3iCUBE CAMERA MOUNTING PLATE	8
AUXILIARY CONNECTION CABLE	8
USB3.0 CABLE	9
USB 3.0 INTERFACE CARD	9
USB 3.0 HUB	9
C-MOUNT LENSES AND ILLUMINATION	10
OPTIONALLY AVAILABLE SOFTWARE ACCESSORIES	10
STANDARD CONFORMITY	10
LEGAL NOTICE	10
ROHS II	10
FCC	10
CE	10
SAFETY PRECAUTIONS	11
GENERAL HANDLING	12
USAGE NOTES	14
READ THE DOCUMENTATION	14
CAMERA POWER	14
OPENING THE CAMERA	14
ENVIRONMENTAL STORAGE CONDITIONS	14
ENVIRONMENTAL OPERATING CONDITIONS	14
MAINTENANCE	15
CLEANING THE SENSOR WINDOW	15
CONNECTORS	15
HANDLE CAREFULLY	15

CHECK COMPATIBILITY OF LENS	16
DROPPING FRAMES.....	16
OCCURRENCE OF MOIRÉ.....	16
ELECTROMAGNETIC FIELDS.....	16
SYSTEM REQUIREMENTS	17
HARDWARE REQUIREMENTS.....	17
SOFTWARE REQUIREMENTS.....	17
iCUBE iCONTROL– VIEWER SOFTWARE	17
SYNVIEW – SOFTWARE DEVELOPMENT KIT (SDK).....	17
SPECIFICATIONS.....	18
<i>OUTLINE DIMENSIONS</i>	18
CAMERA MOUNT	19
LENS MOUNT	19
C-MOUNT.....	19
CS-MOUNT.....	19
INTERFACES	19
CONNECTOR PIN ASSIGNMENT	20
MICRO B USB 3.0 CONNECTOR	21
AUXILIARY I/O CONNECTOR.....	21
I/O SPECIFICATION.....	22
DIGITAL IO INTERFACES.....	22
DIGITAL DATA INPUT.....	22
DIGITAL DATA OUTPUT	23
IMAGE SENSORS	25
IR-CUT OR AR FILTER.....	28
TYPICAL SPECTRAL RESPONSE.....	29
SOFTWARE	36
SOFTWARE CD	36
WINDOWS.....	36
LINUX	37
SOFTWARE INSTALLATION (WINDOWS)	38
SOFTWARE AND DRIVER UPDATE.....	39
PROBLEMS	39
APPLICATIONS.....	40
CALIBRATION (OPTIONAL).....	41
iCUBE SDK SAMPLES (WINDOWS)	42
OVERVIEW STANDARD CAMERA FUNCTIONS	44
<i>ERROR CODES</i>	46
DIRECTSHOW INTERFACES	47
SUPPORTED STANDARD–DIRECTSHOW–INTERFACES.....	47
iCUBE DIRECTSHOW INTERFACE.....	47
iCUBE DIRECTSHOW SETTING	48
CAMERA CONTROL PARAMETERS	50

VIDEO STREAM CONTROL PARAMETERS.....	51
TECHNICAL SUPPORT	52
WEBSITES	52
EMAIL	52
PHONE	52
FAX.....	52
IMPRINT.....	53

List of Figures

FIGURE 1:	C-MOUNT LENS.....	16
FIGURE 2:	3ICUBE HOUSING DIMENSION	18
FIGURE 3:	CAMERA REAR VIEW WITH AUX PIN ORDER (LEFT) AND TRIGGER CABLE (RIGHT)	20
FIGURE 4:	DIGITAL DATA INPUT	22
FIGURE 5:	DIGITAL DATA OUTPUT	23
FIGURE 6:	DIGITAL OUTPUT TIMING DIAGRAM.....	23
FIGURE 7:	IR CUT FILTER CHARACTERISTICS FOR COLOR CAMERAS	28
FIGURE 8:	AR FILTER CHARACTERISTICS FOR BW/IR CAMERAS.....	28
FIGURE 9:	MT9V032 BW.....	29
FIGURE 10:	MT9V032 COLOR	30
FIGURE 11:	MT9M001 BW	30
FIGURE 12:	MT9M131 COLOR.....	31
FIGURE 13:	EV76C560 BW	31
FIGURE 14:	EV76C560 COLOR	32
FIGURE 15:	EV76C661 NIR	32
FIGURE 16:	EV76C570 COLOR + BW	33
FIGURE 17:	MT9T001 COLOR	33
FIGURE 18:	MT9P031 BW	34
FIGURE 19:	MT9P001 COLOR	34
FIGURE 20:	MT9J003 BW.....	35
FIGURE 21:	MT9J003 COLOR	35
FIGURE 22:	DEVICE MANAGER	38
FIGURE 23:	ICONTROL VIEWER SOFTWARE.....	40
FIGURE 24:	MACBETH STANDARD COLOR CHECKER	41
FIGURE 25:	ICUBE DX REGISTRATION.....	42
FIGURE 26:	ICUBE SDK SAMPLE	43
FIGURE 27:	VIDEO CONTROL PARAMETERS.....	48
FIGURE 28:	CAMERA CONTROL PARAMETERS.....	50
FIGURE 29:	VIDEO STREAM CONTROL PARAMETERS	51

List of Tables

TABLE 1: 3ICUBE IMAGE SENSORS 7

TABLE 2: OVERVIEW 19

TABLE 3: USB 3.0 INTERFACE CONNECTOR MICRO B..... 21

TABLE 4: AUXILIARY I/O CONNECTOR PIN ASSIGNMENT 21

TABLE 5: DIGITAL INPUT CHARACTERISTICS 22

TABLE 6: DIGITAL OUTPUT CHARACTERISTICS..... 24

TABLE 7: IMAGE SENSORS WVGA AND SXGA 25

TABLE 8: IMAGE SENSORS SXGA AND UXGA 26

TABLE 9: IMAGE SENSORS QXGA AND WQUXGA 27

TABLE 10: STANDARD CAMERA FUNCTION CONTROL 44

TABLE 11: ERROR CODES 46

TABLE 12: VIDEO CONTROL PARAMETERS 49

TABLE 13: CAMERA CONTROL PARAMETERS..... 50

TABLE 14: VIDEO STREAM CONTROL PARAMETERS 51

General information

Scope of the manual

This manual introduces the 3iCube camera series and covers all common aspects of work with these cameras. Technical specifications and other model-specific data are listed in section [Specifications](#) p.18 .

Related documents

- SDK manual
- SynView Quick Start Guide — SynView SDK package overview, installation instructions and quick start guide
- SynView Programmers Guide — SynView API reference guide with programming examples

Overview

NET's easy to use compact camera with USB 3.0 interface taps the full potential of the latest CMOS image sensors to set new standards in regard of achievable frames rates and image quality. It supports 24-bit RGB true color while offering a high speed interface to meet the most challenging applications like multi-camera systems.

Table 1: 3iCube Image Sensors

Model b/w - NIR - color	Sensor	Image Sensor	Resolution (H*V) [pixel]	Sensor size	Shutter	Frame rate [fps]
IC1044CU	CMOS	MT9V032	752 x 480 / WVGA	1/3"	global	86
IC1044BU	CMOS					
IC1130CU	CMOS	MT9M131	1280 x 1024 / SXGA	1/3"	rolling	24
IC1130BU	CMOS	MT9M001		1/2"		23
IC4133CU	CMOS	EV76C560	1280 x 1024 / SXGA	1/1.8"	global; rolling; global reset	60
IC4133BU	CMOS					
IC4133IR	CMOS	EV76C661	1280 x 1024 / SXGA	1/1.8"		
IC4203CU	CMOS	EV76C570	1600 x 1200 / UXGA	1/1.8"	global; rolling; global reset	47
IC4203BU	CMOS					
IC1300CU	CMOS	MT9T001	2048 x 1536 / QXGA	1/2"		
IC1500CU	CMOS	MT9P001	2592 x 1944 / QSGA	1/2.5"	12	
IC1500BU	CMOS	MT9P031	2592 x 1944 / QSGA	1/2.5"	14	
IC11000CU	CMOS	MT9J003	3664 x 2748 / WQUXGA	1/2.3"	7.5	
IC11000BU	CMOS					

Scope of Delivery

Content

- 3iCube is offered as follows
 - image sensor: see [Table 1: 3iCube Image Sensors](#)
 - versions: industrial (housing) or board-level
 - mount: C-/CS mount
- CD-ROM including
 - 3iCube iControl viewer software
 - 3iCube USB Driver Windows and Linux (32/64bit)
 - 3iCube Software Development Kit (SDK)
 - 3iCube SDK Manual
 - 3iCube Operational Manual (this document)

Options

- 3iCube can be further customized with the following configuration options:
 - Customized firmware
 - Real-time processing

Optionally available hardware accessories

The 3iCube camera product does not include any accessories. Other equipment must be provided separately. System components necessary for using this camera series are listed below:

3iCube camera mounting plate

The mounting plate can be attached to the bottom of the camera and allows the camera to be mounted on a tripod with a 1/4" screw. The 3iCube camera mounting plate comes with four 6mm M3 screws (screw acceleration M3 / 2/54 = 0.3Nm / 1/4" = 7Nm)

- CA-Base-Plate-: **Order number 05005600xx (*1)**

Auxiliary connection cable

This cable allows you to connect digital IO and auxiliary power to the camera. The cable is 5m long with a header on one side fitting into the 3iCube auxiliary I/O connector.

- CA-iCube-TRIGGER-5m: Standard cable **Order number 06087600xx (*1)**
- ZY-iCube-TRIGGER-TC-5m: trailer chain cable **Order number 06091100xx (*1)**

USB3.0 Cable

This cable is used to connect the camera to host equipment. USB packets (stream and control) are transmitted via this cable. Please use a USB 3.0 cable that supports USB 3.0 super speed. This product is able to connect a USB3.0 cable that is equipped with screw lock mechanism.

- CA-USB3/A-microB/screw/2m/Metric: **Order number 06092601xx (*1)**
- CA-USB3/A-microB/screw/3m/Metric: **Order number 06092600xx (*1)**
- CA-USB3/A-microB/screw/5m/Metric: **Order number 06092602xx (*1)**
- CA-USB3/A-microB/screw/8m/Metric: **Order number 06092604xx (*1)**

Trailer chain USB 3.0 cables are on request.

USB 3.0 Interface Card

This is the interface card to connect to the camera. Usually this card is installed to a PCIe expansion slot of host PC etc. Please use an USB3.0 interface card with USB 3.0 controller, which support s USB 3.0 super speed.

for PCI Express slot

- IP-PCI-Express-2x-USB3.0: **Order number 14002300xx (*1)**
- IP-PCI-Express-4x-USB3.0: **Order number 14002700xx (*1)**

for Express Card slot (for Notebook)

- IP-ExpressCard-2x-USB3.0: **Order number 14002500xx (*1)**

USB 3.0 Hub

standard hub incl. power supply

- IP-HUB-4x-USB3.0: **Order number 14002400xx (*1)**

Hub with DIN RAIL Mounting Kit

- IP-ExpressCard-2x-USB3.0: **Order number 14002600xx (*1)**

**1: Optional part. Contact your NET sales contact for details of option units.*

C-mount lenses and Illumination

NET offers a wide variety of suitable lenses & illumination. Contact your NET sales partner for details.

Optionally available software accessories

- 3iCube calibration tool (see chapter Calibration (optional))

Standard Conformity

Legal Notice

The cameras fully implement the USB3.0 standard.

RoHS II

The product fulfills the requirements of the **EU directive RoHS 2011/65/EU** in the currently valid version from 8 June 2011 regarding the restrictive use of certain hazardous materials in electric applications within the allowable limits.

FCC

This equipment has been tested and found to comply with the limits for a **class A** digital device, pursuant to Part 15 of the FCC Rules. These limits are designed to provide reasonable protection against harmful interference when the equipment is operated in a commercial environment.

This equipment generates, uses, and can radiate radio frequency energy and, if not installed and used in accordance with the instruction manual, may cause harmful interference to radio communication.

Operation of this equipment in a residential area is likely to cause harmful interference in which case the user will be required to correct the interference at his own expense.

CE



This apparatus has been certified to meet or exceed the standards for CE compliance per Council Directives. Pertinent testing documentation is available for verification. This product following the provision of directive 2004/108/EC.

Safety Precautions

Before using this product read these safety precautions carefully. Important information is shown in this Operational Manual to protect users from injuries and property damages and to enable them to use the product safely and correctly.

Please be sure to thoroughly understand the meanings of the following signs and symbols before reading the main text that follows, and observe the instructions given herein.

[Definition of Safety Signs]

Safety Signs	Description
 WARNING	Indicates a potentially hazardous situation that may result in death or serious injury (*1) in the event of improper handling.
 CAUTION	Indicates a potentially hazardous situation that may result in light to moderate injuries (*2) or only in property damage (*3) in the event of improper handling.



Notes

*1: "Serious injury" refers to cases of loss of eyesight, wounds, burns (high or low temperature), electric shock, broken bones, poisoning, etc., which leave after-effects or which requires hospitalization or a long period of outpatient treatment of cure.

*2: "Light to moderate injuries" refers to injuries, burns, electric shock etc. that do not require hospitalization or long-term treatment.

*3: "Property damage" refers to cases of extensive damage involving damage to buildings, equipment, farm animals, pet animals and other belongings.

[Explanation of Safety Symbols]

Safety Symbols	Description
 PROHIBITED	This sign indicates PROHIBITION (Do not). The content of prohibition is shown by a picture or words beside the symbol.
 MANDATORY	This sign indicates MANDATORY ACTION (You are required to do). The content of action is shown by a picture or words beside the symbol.

General Handling

WARNING



Unplug

Stop operation immediately when any abnormality or defect occurs.

If abnormal conditions are present, such as smoke, a burning smell, ingress of water or foreign matter, or if the equipment is dropped or malfunctions, fire or electric shock may result. Be always sure to disconnect the power cable from the wall socket at once and contact your dealer.



wet

Do not use the equipment in locations subject to water splashes. Otherwise, fire or electric shock may result.



Never pull
apart

Do not disassemble, repair, or modify the equipment. Otherwise, fire or electric shock may result. For internal repair, inspection or cleaning, contact your sales representative.



Avoid

Do not place anything on the equipment.

If metallic objects, liquid, or other foreign matter enters the equipment, fire or electric shock may result.



Avoid

Do not install the equipment in an unstable or inclined location or locations subject to vibration or impact. Otherwise, the equipment may topple over and cause personal injury.



Do not touch

During an electrical storm, do not touch the power cable and the connection cable. Otherwise, an electric shock may result.



Instruction

Use the specified voltage. Use of an unspecified voltage may result in fire or electric shock.



Avoid

Do not handle roughly, damaged, fabricated, bent forcefully, pulled, twisted, bundled, placed under heavy objects or heated the power cable and the connection cable. Otherwise, fire or electric shock may result.

CAUTION



Instruction

Observe the following when installing the equipment:

Do not cover the equipment with a cloth, etc.

Do not place the equipment in a narrow location where heat is likely to accumulate.

Otherwise, heat will accumulate inside the equipment, possibly resulting in a fire.



Avoid

Do not place the equipment in locations subject to high moisture, oil fumes, steam, or dust. Otherwise, fire or electric shock may result.



Avoid

Do not install the equipment in locations exposed to direct sunlight or humidity.

Otherwise, the internal temperature of the equipment will rise, which may cause a fire.



Instruction

Use only specified the power cable and the connection cables. Otherwise, fire or electric shock may result.



Avoid

Do not give strong impact against the equipment. It may cause the trouble.



Instruction

When performing connection, turn off power. When connecting the power cable and the connection cable, turn off the equipment power. Otherwise, fire or electric shock may result.



Avoid

Do not expose the camera head to any intensive light (such as direct sunlight). Otherwise, its inner image pickup device might get damaged.



Avoid short-circuiting signal output. Otherwise, a malfunction may occur.



Avoid giving a strong shock against the camera body. It might cause a breakdown or damage. If your camera is used in a system where its camera connector is subjected to strong repetitive shocks, its camera connector is possible to break down. If you intend to use your camera in such a situation, if possible, bundle and fix a camera cable in the place near the camera, and do not transmit a shock to the camera connector.

Usage Notes

Read the documentation

Read the camera documentation before using the camera.

Camera power

Incorrect power input can damage the camera. Do not reverse power polarity. Do not connect or disconnect other cables when the camera power is on. Use always a USB 3.0 cable as power supply supported by USB 3.0 port.

Opening the camera

Do not open the camera. Do not let liquid, dust, flammable or metallic material get inside the camera.

Environmental storage conditions

Temperature: -20°C ~ 60°C (- 4°F 140°F)

Humidity: 90% or less (no condensation)

Environmental operating conditions

Always use the camera in conditions meeting the specification in this chapter. Do not use the product in locations where the ambient temperature or humidity exceeds the specifications. In a thermal challenging environment the customer needs to ensure sufficient heat dissipation with a thermal connection to the bottom of the camera housing and sufficient airflow.

Non-adequate thermal connection may increase heat induced noise or degrade image quality in other ways and internal components may be adversely affected up to camera outages due to overheating.

Temperature	Range	Measurement
Environmental	0°C ~ 45°C (32°F 113°F)	close to the camera case
Camera housing	≤ 50°C	at camera case

Humidity (non-condensing)	Relative
Environmental	20 %–90 %

The conditions for shock and vibrations can be requested from NET.

Maintenance

Turn off power to the equipment and wipe it with a dry cloth. If it becomes severely contaminated, gently wipe the affected areas with a soft cloth dampened with diluted neutral detergent. Never use alcohol, benzene, thinner, or other chemicals because such chemicals may damage or discolor the paint and indications.

Cleaning the sensor window

Avoid cleaning the sensor window if possible. Keep lens cap closed as long as no lens is attached, avoid touching the sensor. If necessary, clean the sensor window using compressed air. If further cleaning is required, use lint-free, ESD-safe cloth wiper. Avoid cloth that could generate static charge or that could scratch the window. The camera should be cleaned in an ESD-safe area. The person performing cleaning should be earthed.

Connectors

Take care when handling the camera so that no damage can be done to the connectors. Prevent contact with foreign objects.

Handle carefully

Always transport the camera in its original packaging. Do not drop the equipment or allow it to be subject to strong impact or vibration, as such action may cause malfunctions. Do not damage the connection cable, since this may cause wire breakage. If the camera is not in use, attach the lens cap to the camera to protect the image pickup surface. If the equipment is not to be used for a long duration, turn off power to the camera for safety.

Check compatibility of lens

Depending on lens and lighting an image can be reflected as a ghost into the imaging area. This is not a fault of the camera. Depending on the lens the performance of the camera might not be brought out fully due to deterioration in resolution and brightness in the peripheral area, aberration and other side effects. Be sure to check lens and lightning you plan to use for compatibility with your camera. When installing a lens in the camera make sure that it is not tilted. Use a mounting screw free from defects and dirt. Otherwise the lens might not be removable from the camera.

Install lenses with a protrusion from bottom of the screw equal or less than 10 mm. If a lens does not fulfill this condition it might damage the camera when trying to be installed.

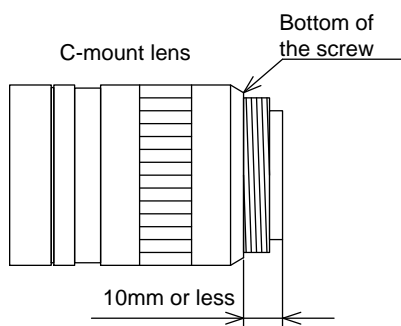

Figure 1: C-Mount Lens

Dropping Frames

Depending on your computer or USB3.0 interface board configurations, images may not be captured properly (e.g. dropping frames). In this case, change pixel clock setting to lower value.

Occurrence of moiré

If you shoot thin stripe patterns, moiré patterns (interference fringes) may appear. This is not a malfunction.

Electromagnetic fields

Keep the camera away from strong electromagnetic fields. Avoid static charging and handle the camera in ESD protected area. If an intense magnetic or electromagnetic field is generated near the camera or connection cable, noise may be generated on the screen. If this occurs, move the camera or the cable.

Following information is only for EU-member states:

The use of the symbol indicates that this product may not be treated as household waste. By ensuring this product is disposed correctly, you help to prevent potential negative consequences for the environment and human health, which could otherwise be caused by inappropriate waste handling of this product. For more detailed information about the take-back and recycling of this product, please contact your supplier where you purchased the product.



System Requirements

Hardware requirements

- USB 3.0 on board Interface. NET successfully tested USB 3.0 adapters, which use the Renesas chipset μ PD720202 or μ PD720200A. Please be sure that you installed the latest USB 3.0 adapter driver.
- lockable SuperSpeed USB 3.0 cable up to 3m. If you want to use your own USB 3.0 cables, you have to ensure that the data quality and shielding of the cable is sufficient. Better cable qualities which go alongside with thicker cable diameter will allow longer distances. We recommend using the cables that we supply.
- state of the art computer or notebook. (minimum Pentium IV processor with a clock frequency of at least 1.5 GHz or higher)

Software requirements

iCube iControl– Viewer Software

The iControl software allows you to test the functionalities of the 3iCube camera on your own application. Apart from controlling the 3iCube camera, you can grab images and save them as jpg, bmp and tiff files

SynView – Software Development Kit (SDK)



/ only with USB3 Vision

compliance	USB 3.0 standard
supported image processing libraries	Adaptive Vision Studio, Halcon, Imaging Library, VisionPro, LabView Vision, Matlab (and all GenTL consumer)
supported operating systems	Windows XP (32 bit), Windows 7 (32/64 bit), Windows 8 (32/64 bit), Linux (32/64 bit)

All necessary drivers for Windows and Linux are contained on the CD-ROM. For newer driver versions we recommend to visit NET's website www.net-gmbh.com.

Specifications

Outline Dimensions

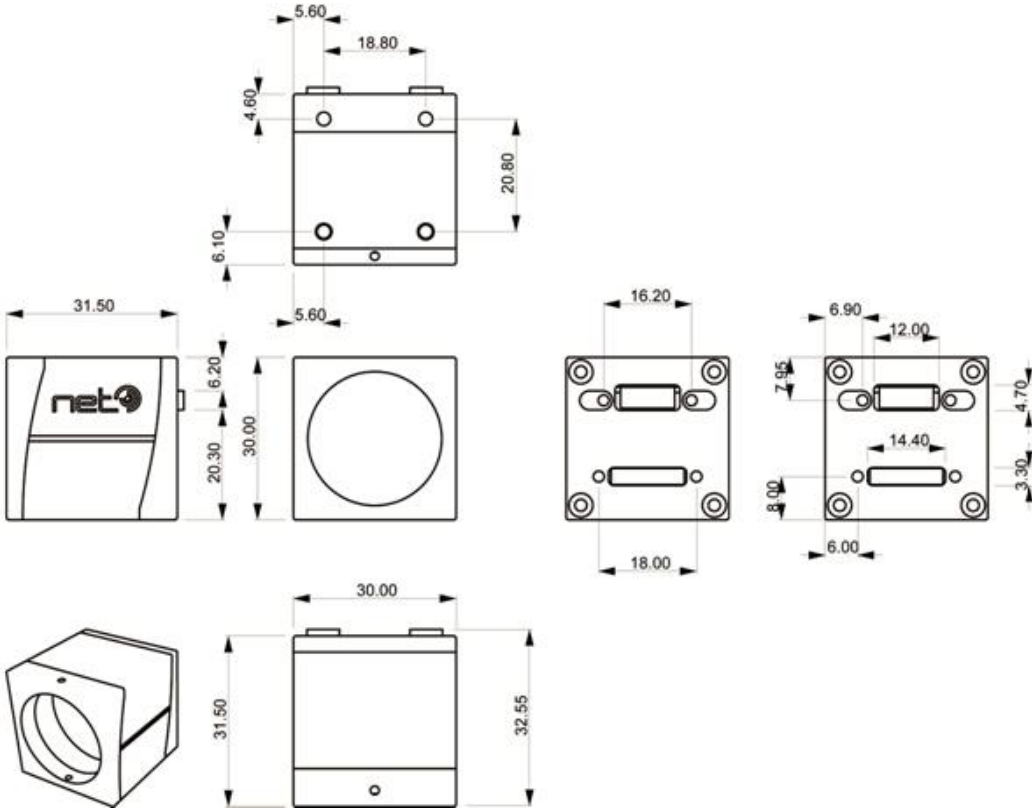

Figure 2: 3iCube Housing Dimension

camera body weight:

industrial version: 38 g

board-level version: 13 g

(screw acceleration M3 / 2/54 = 0.3Nm / 1/4" = 7Nm)

CAD files on request.

Camera Mount

4 mounting screw holes are available on the camera's bottom side to mount the camera on the 3iCube camera mounting plate, two close to the front side and two close to the back side of the camera as outlined in Figure 2: 3iCube Housing Dimension. The holes are M3 and screw length of 3mm is allowed.

Lens Mount

C-Mount

All 3iCube models are equipped in the factory with a C-mount adapter (1-inch thread diameter, 32 threads per inch, 17.526 mm flange back) which is adjusted to precisely fulfill the C-mount flange back distance. Modifications to this adjustment are strongly discouraged since the factory precision is lost.

CS-Mount

The 3iCube camera supports CS-Mount with 12.5 mm flange back after removing the C-Mount adapter from the camera head. To remove the C-Mount adapter the two 1mm hex-socket screws on the top and bottom side of the camera's head can be released. After the two screws in the mounting points are loosened the C-mount adapter can be released. The CS-Mount lens can then be installed directly into the camera's head. When finished with adjusting fasten the flange back position of the lens with the two screws again to fix your adjustments.

Interfaces

Table 2: Overview

standard USB 3.0 connector	USB 3.0 micro B with screw locking
USB 3.0 cable	3 twisted pair (shielded), 1 pair unshielded, cable full shielded, super speed (for up to 5Gbit/s)
USB 3.0 cable length	up to 3m (longer cables on request by NET)
auxiliary cable connector	8 pin connector,
digital input/output	external trigger input (Line0) = opto coupled (open collector) external strobe output (Line1) = opto coupled (open collector) 3x GPIO (optional)

Note:

Please check if the power supply of the camera is switched off before plugging in or pulling out the I/O connector. Always use a USB 3.0 cable with a lock screw and secure the camera cable as close as possible to the camera body in order to avoid physical damage to the camera connector and electronics.

Connector Pin Assignment

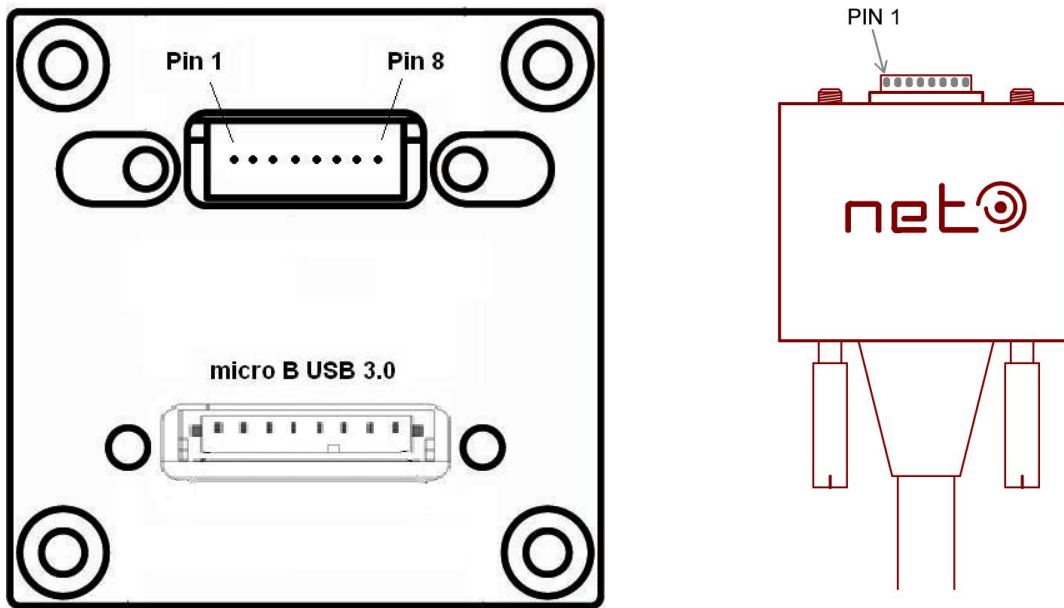

Figure 3: Camera rear view with AUX pin order (left) and trigger cable (right)

Micro B USB 3.0 Connector

The camera uses the USB 3.0 interface and is fully compatible with the USB 3.0 standard.

Table 3: USB 3.0 Interface Connector micro B

Pin No.	I/O	Signal	Function
1	-	VBUS	Power
2	I/O	D-	USB 2.0 differential pair
3	I/O	D+	USB 2.0 differential pair
4	I/O	ID	DPWR
5	-	GND	Ground
6	I/O	SSTX-	Super speed transmitter differential pair
7	I/O	SSTX+	Super speed transmitter differential pair
8	-	GND	Ground for signal
9	I/O	SSRX-	Super speed receiver differential pair
10	I/O	SSRX+	Super speed receiver differential pair
shell	-	GND	shield

Auxiliary I/O Connector

The camera has an 8pin connector to connect digital IO

Table 4: Auxiliary I/O Connector pin assignment

Pin No.	I/O	Signal	Function
1	I	LINE 0	Trigger Input
2	I	LINE 0 GND	Trigger Input GND
3	O	LINE 1	Strobe 1 Output
4	O	LINE 1 GND	Strobe 1 Output GND
5	I/O	GPIO 1	(optional)
6	I/O	GPIO 2	(optional)
7	I/O	GPIO 3	(optional)
8	-	GND	Power GND

I/O Specification

Digital IO interfaces

Digital IO's of the 3iCube Camera are electrically decoupled by opto couplers to prevent damage or unwanted interference by ground loops or block voltage spikes. An opto coupler is a device using optical path to transfer an electronic signal between two circuits. It consists of a photodiode converting the input signal to light and a phototransistor converting the light again to electronic signal. 3iCube cameras provide 1 digital input and 1 digital output that way.

Digital Data Input

The digital input (Line0) can be used for trigger applications or other synchronization tasks for 3iCube cameras. An external signal level from 0~0.5V is interpreted as **Low**, a level from 3.3~24V is interpreted as **High**.

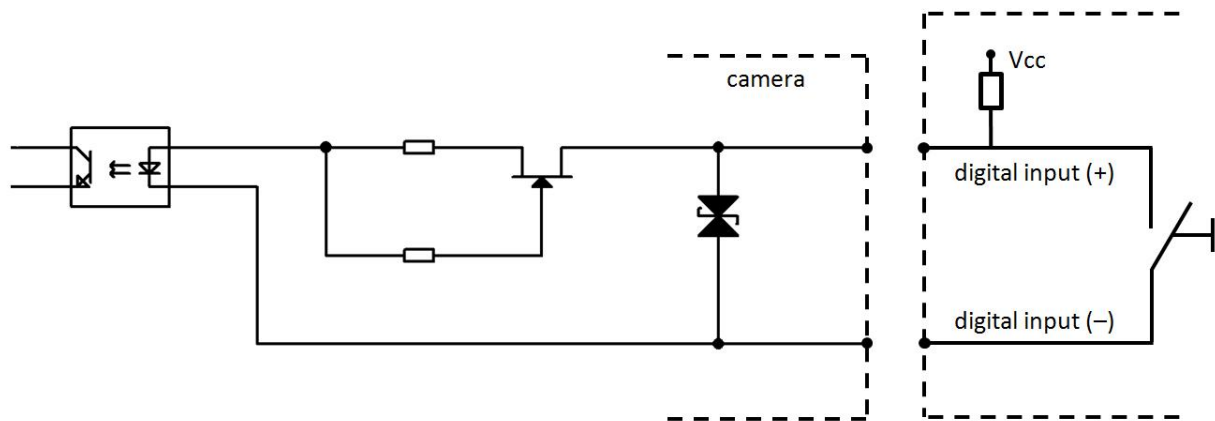

Figure 4: Digital Data Input

Table 5: Digital Input Characteristics

Parameter	Value
Operating voltage	0-24 V
Input current	7.5 mA
External resistor requirement	No
ON voltage level	> 3.3 V
OFF voltage level	< 0.5 V
OFF to ON delay	< 4 μ s
ON to OFF delay	< 40 μ s

Note:

For external trigger application a rising/falling edge signal is recommended to minimize the time it takes for the opto-coupler to change state.

Digital Data Output

The digital outputs (Line1/2) can be used for strobe applications or to control other external devices.

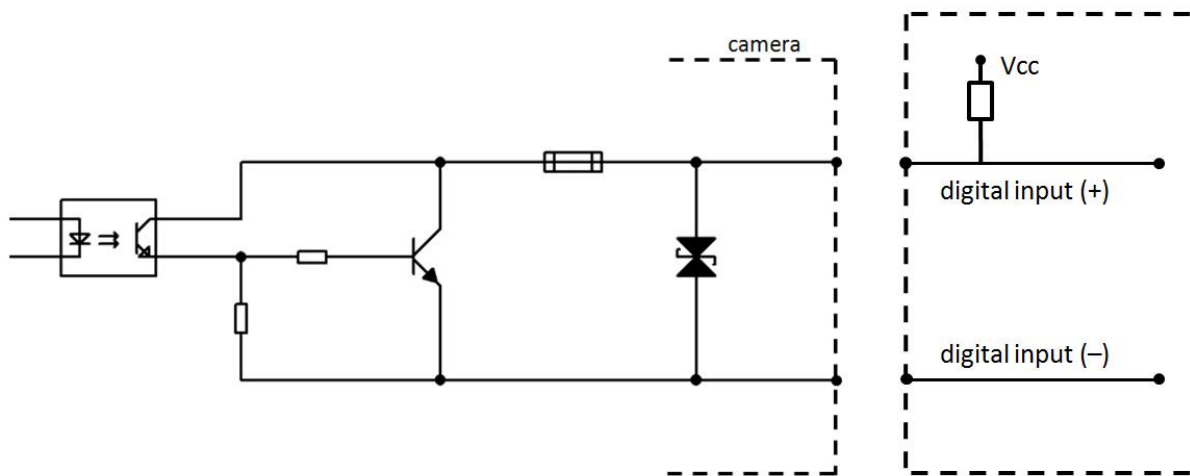

Figure 5: Digital Data Output

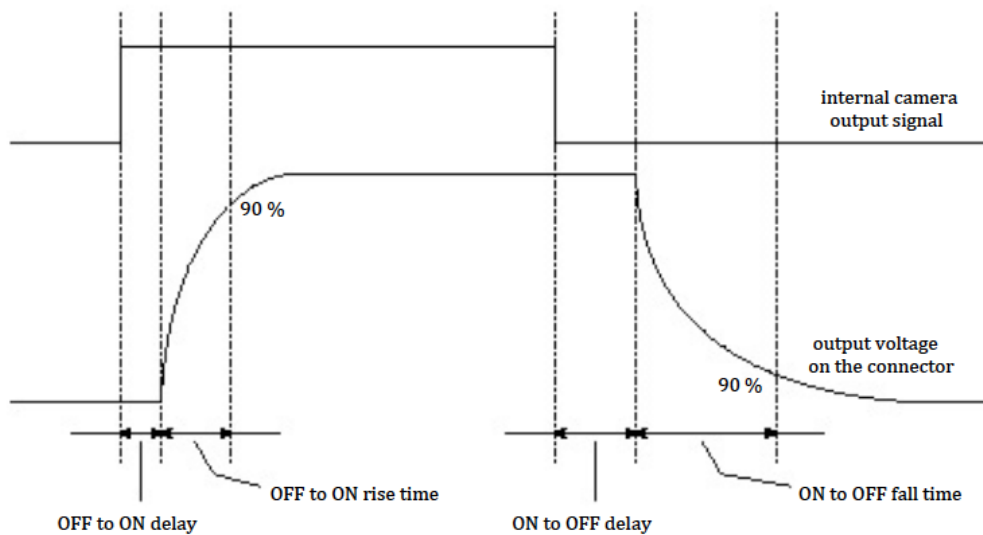

Figure 6: Digital Output Timing Diagram

Parameter	Value
Operating voltage	3.3—24 V
Output current	100 mA
External resistor requirement	Yes
Slew rate rising	0.2V/ μ s
Slew rate falling	2.0V/ μ s
OFF to ON delay	30 μ s
ON to OFF delay	3 μ s

Table 6: Digital Output Characteristics

Note:

An external strobe application should use the falling edge of the camera output signal to minimize the overall strobe delay.

GPIO Specification (optional):

- Low level -0.3V to +0.8V
- High level 2.1V to 3.6V

Note:

Internal 100 Ohm resistor prevents damage through short circuit on the GPIO ports.

Image Sensors

Table 7: Image Sensors WVGA and SXGA

	IC1044CU	IC1044BU	IC1130CU	IC1130BU
resolution (H*V) [pixel]	752 x 480 WVGA	752 x 480 WVGA	1280 x 1024 SXGA	1280 x 1024 SXGA
sensor	CMOS	CMOS	CMOS	CMOS
image sensor	MT9V032	MT9V032	MT9M131	MT9M001
sensor size	1/3"	1/3"	1/3"	1/2"
pixel size [µm]	6.0 x 6.0	6.0 x 6.0	3.6 x 3.6	5.2 x 5.2
aspect ratio	14:9	14:9	5:4	5:4
frame rate [fps]	86	86	24	26
shutter	global	global	rolling	rolling
shutter speed	0.062 - 745 m s	0.024 - 763 ms	0.039 - 633 ms	0.02 - 394 ms
data path	10 bit	10 bit	10 bit	10 bit
binning	2 x 2, 4 x 4	2 x 2, 4 x 4	2 x 2, 4 x 4	2 x 2, 4 x 4
partial scan	ROI	ROI	ROI	ROI
pixel clock frequency	26.6MHz	26.6MHz	26.6MHz	26.6MHz
responsivity	4.8 V/lux/s	4.8 V/lux/s	4.8 V/lux/s	4.8 V/lux/s

Table 8: Image Sensors SXGA and UXGA

	IC4133CU	IC4133BU	IC4133IR	IC4203CU	IC4203BU
resolution (H*V) [pixel]	1280 x 1024 SXGA	1280 x 1024 SXGA	1280 x 1024 SXGA	1600 x 1200 UXGA	1600 x 1200 UXGA
sensor	CMOS	CMOS	CMOS	CMOS	CMOS
image sensor	EV76C560	EV76C560	EV76C661	EV76C570	EV76C570
sensor size	1/1.8"	1/1.8"	1/1.8"	1/1.8"	1/1.8"
pixel size [µm]	5.3 x 5.3	5.3 x 5.3	5.3 x 5.3	4.5 x 4.5	4.5 x 4.5
aspect ratio	5 : 4	5 : 4	5 : 4	4 : 3	4 : 3
frame rate [fps]	60	60	60	47	47
shutter	global; rolling; global reset	global; rolling; global reset	global; rolling; global reset	global; rolling; global reset	global; rolling; global reset
shutter speed	0.031 - 1030 ms	0.031 - 1030 ms	0.031 - 1030 ms	0.035 - 1136 ms	0.035 - 1136 ms
data path	10 bit	10 bit	10 bit	10 bit	10 bit
binning	2 x 2	2 x 2	2 x 2	2 x 2	2 x 2
partial scan	ROI	ROI, linescan	ROI, linescan	ROI	ROI, linescan
pixel clock frequency	120MHz	120MHz	120MHz	120MHz	120MHz
responsivity	6600 LSB10/lux/s	6600 LSB10/lux/s	13000 LSB10/lux/s	7400 LSB10/lux/s	7400 LSB10/lux/s

Table 9: Image Sensors QXGA and WQUXGA

	IC1300CU	IC1500CU	IC1500BU	IC11000CU	IC11000BU
resolution (H*V) [pixel]	2048 x 1536 QXGA	2592 x 1944 QXGA	2592 x 1944 QXGA	3664 x 2748 WQUXGA	3664 x 2748 WQUXGA
sensor	CMOS	CMOS	CMOS	CMOS	CMOS
image sensor	MT9T001	MT9P001	MT9P031	MT9J003	MT9J003
sensor size	1/2"	1/2.5"	1/2.5"	1/2.3"	1/2.3"
pixel size [µm]	3.2 x 3.2	2.2 x 2.2	2.2 x 2.2	1.67 x 1.67	1.67 x 1.67
aspect ratio	4 : 3	4 : 3	4 : 3	4 : 3	4 : 3
frame rate [fps]	12	12	14	7.5	7.5
shutter	rolling with global reset	rolling with global reset	rolling with global reset	rolling with global reset	rolling with global reset
shutter speed	0.056 ms - 50 s	0.074 ms - 77 s	0.085 ms - 89 s	0.146 ms - 135 s	0.146 ms - 135 s
data path	10 bit	12 bit	12 bit	12 bit	12 bit
binning	2 x 2, 4 x 4	2 x 2, 4 x 4	2 x 2, 4 x 4	2 x 2, 4 x 4	2 x 2, 4 x 4
partial scan	ROI	ROI	ROI	ROI	ROI
pixel clock frequency	48MHz	96MHz	96MHz	80MHz	80MHz
responsivity	1.0 V/lux/s	1.4 V/lux/s	1.4 V/lux/s	0.31 V/lux/s	0.31 V/lux/s

IR-cut or AR filter

All camera models have by default either an IR-cut filter (color camera) or an AR (anti-reflective) filter (BW/IR camera) mounted on top of the sensor.

T_{average}	≥ 92%	420nm	620nm
T_{min}	≥ 88%	420nm	620nm
T	= 50%	650nm	± 10nm
T_{average}	≤ 5%	690nm	1100nm

T = transmission

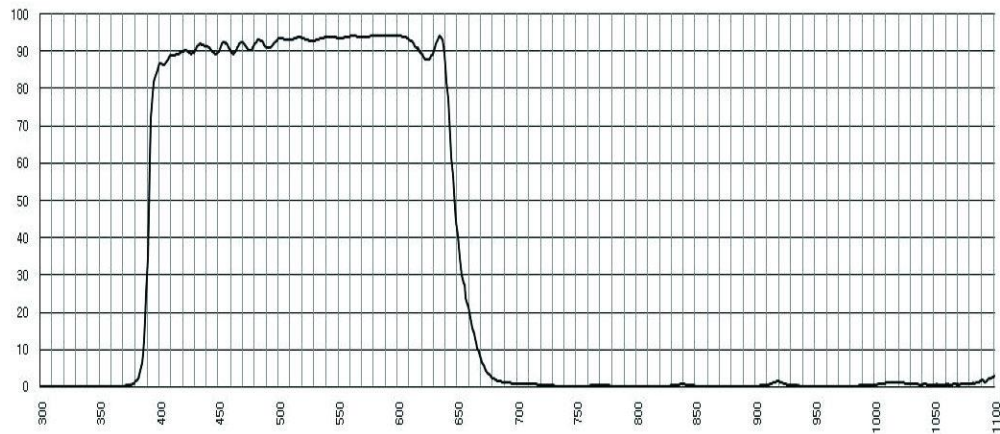

Figure 7: IR cut filter characteristics for color cameras

T_{average}	≥ 97%	420nm	680nm
T_{absn}	≥ 92%	420nm	680nm

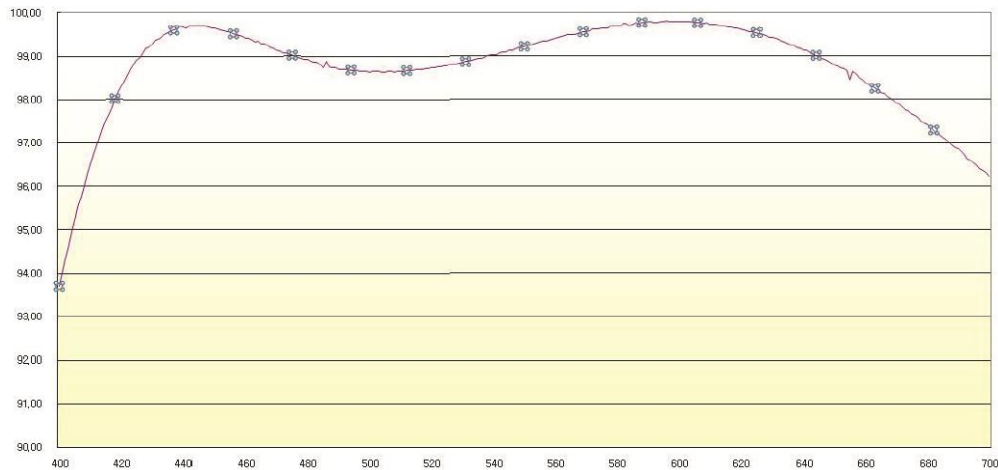

Figure 8: AR filter characteristics for BW/IR cameras

Removing the filter

The C-mount flange distance from the sensor is adjusted for the use of either filter. Removing the filter will decrease the length of the optical path and changed the optical properties. This will make a readjustment necessary and in some cases it might become impossible to focus properly.

Typical Spectral Response

Excerpts from sensor datasheets.

Note that lens and illumination characteristics are not reflected by this data.

IC1044BU

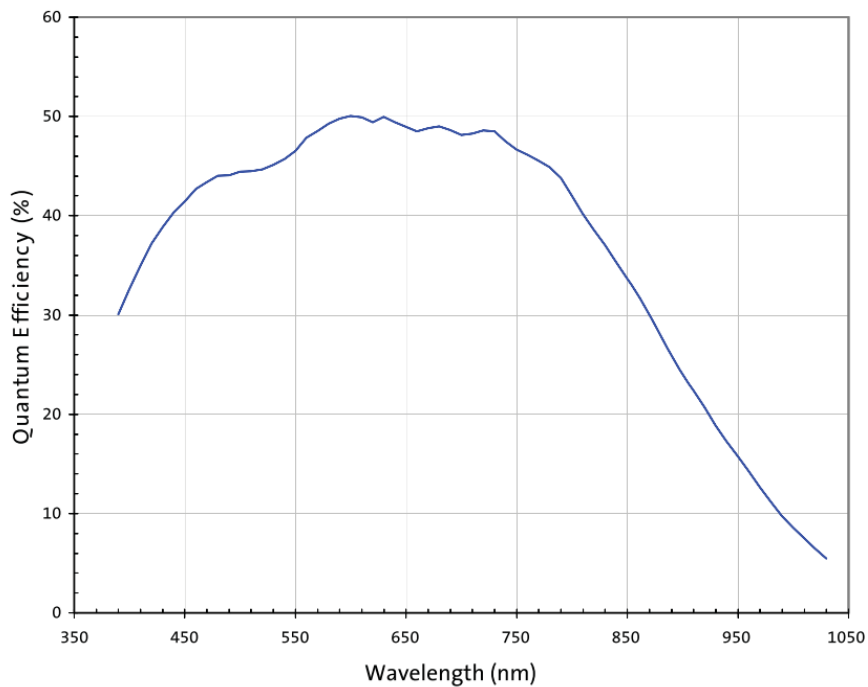

Figure 9: MT9V032 BW

IC1044CU

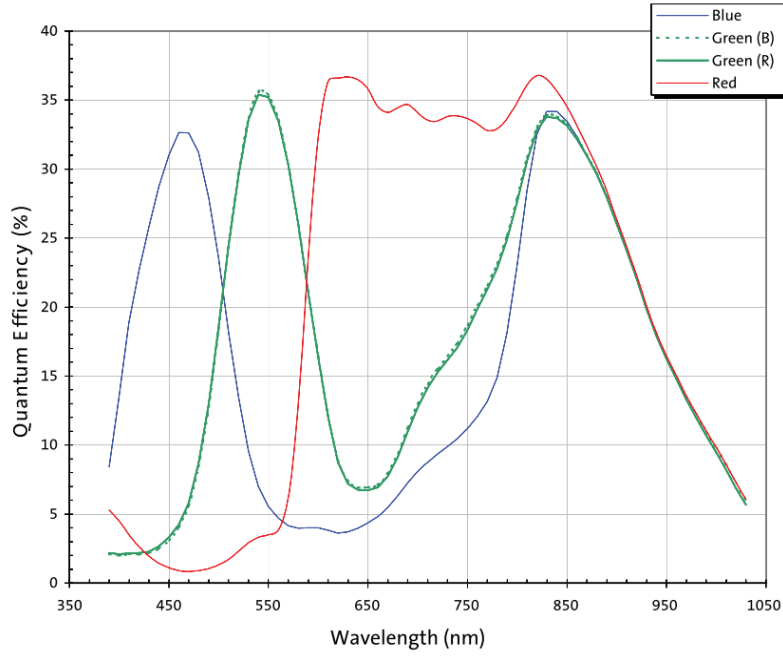

Figure 10: MT9V032 Color

IC1130BU

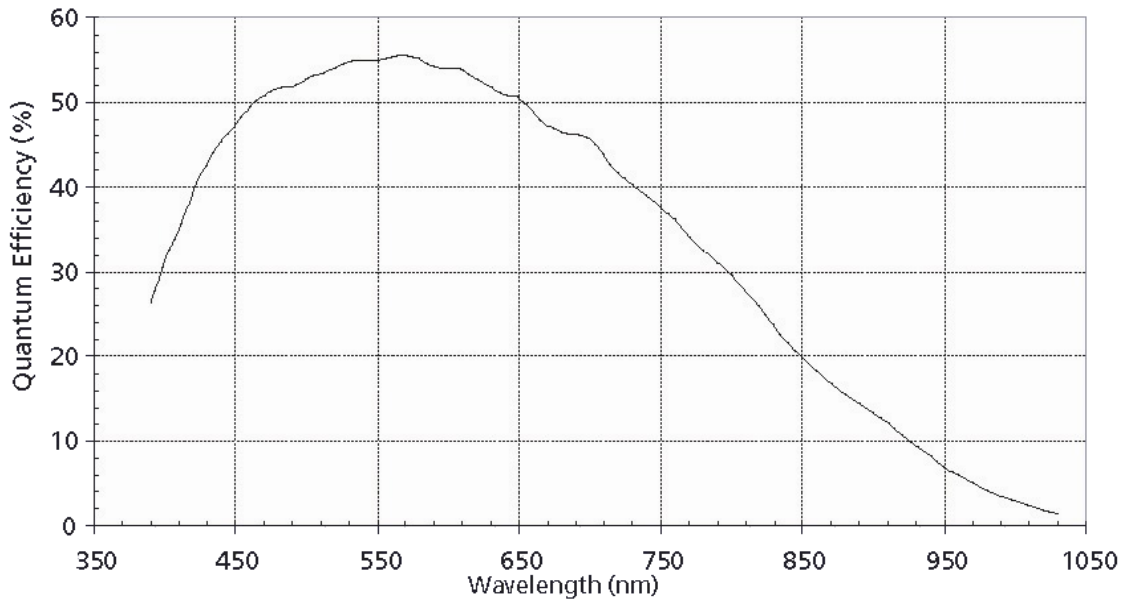

Figure 11: MT9M001 BW

IC1133CU

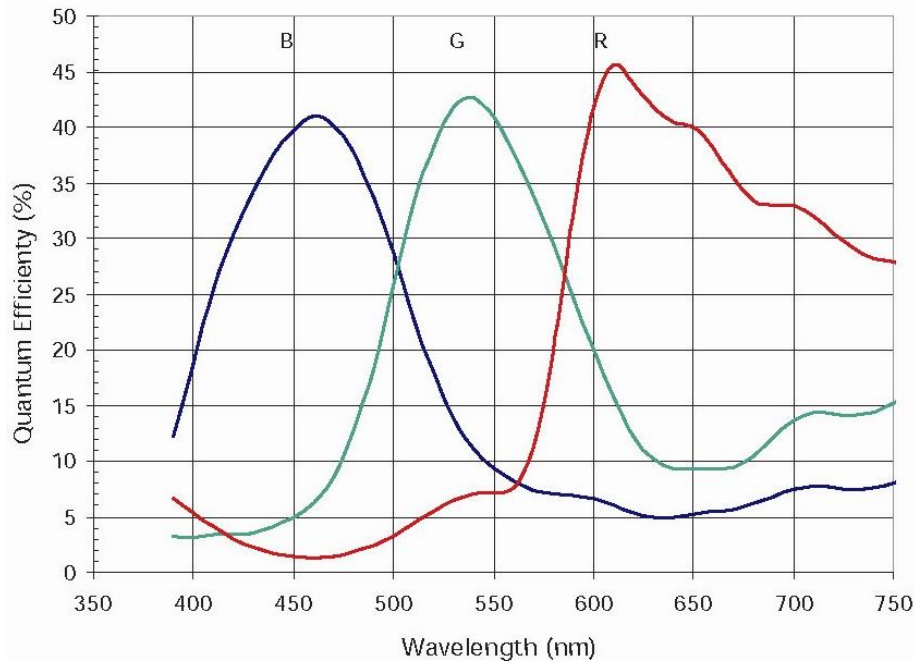

Figure 12: MT9M131 Color

IC4133BU

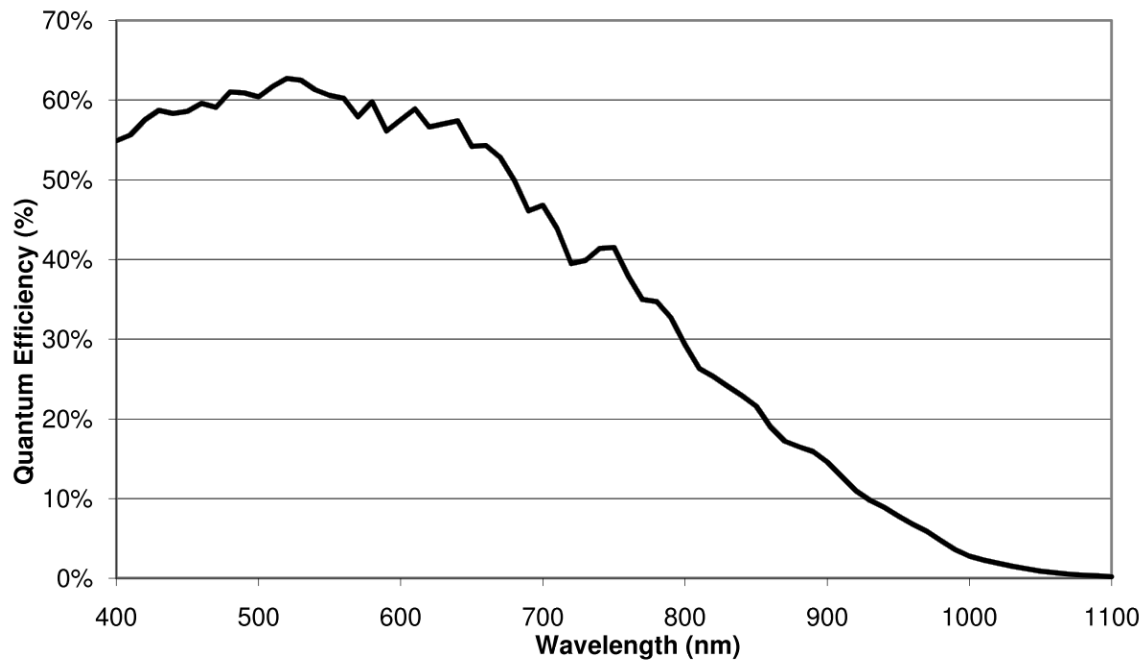

Figure 13: EV76C560 BW

IC4133CU

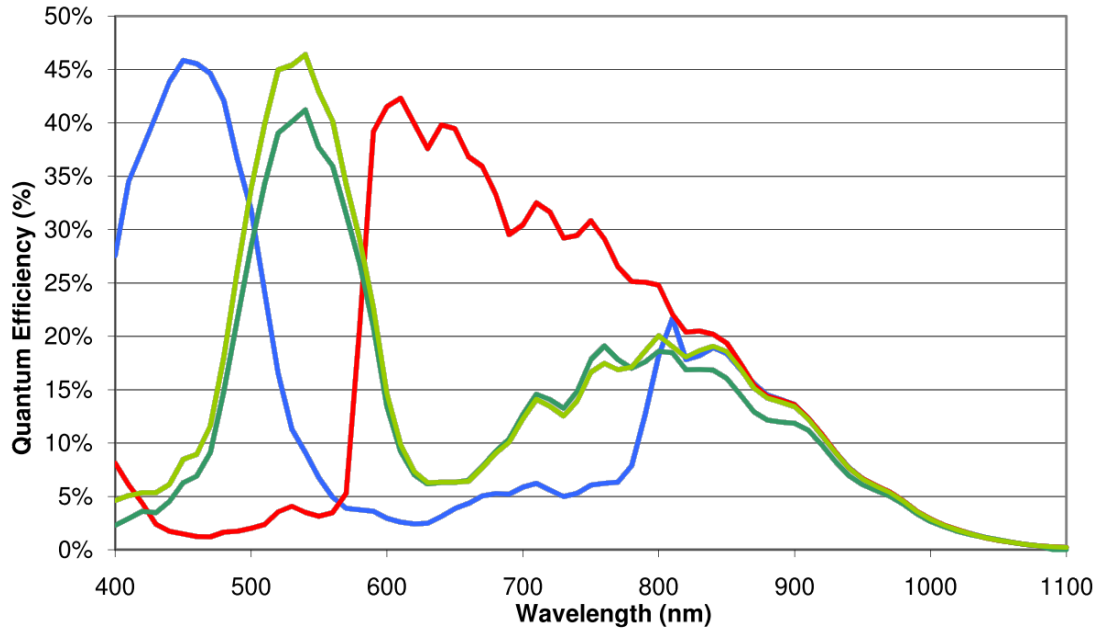

Figure 14: EV76C560 Color

IC4133IR

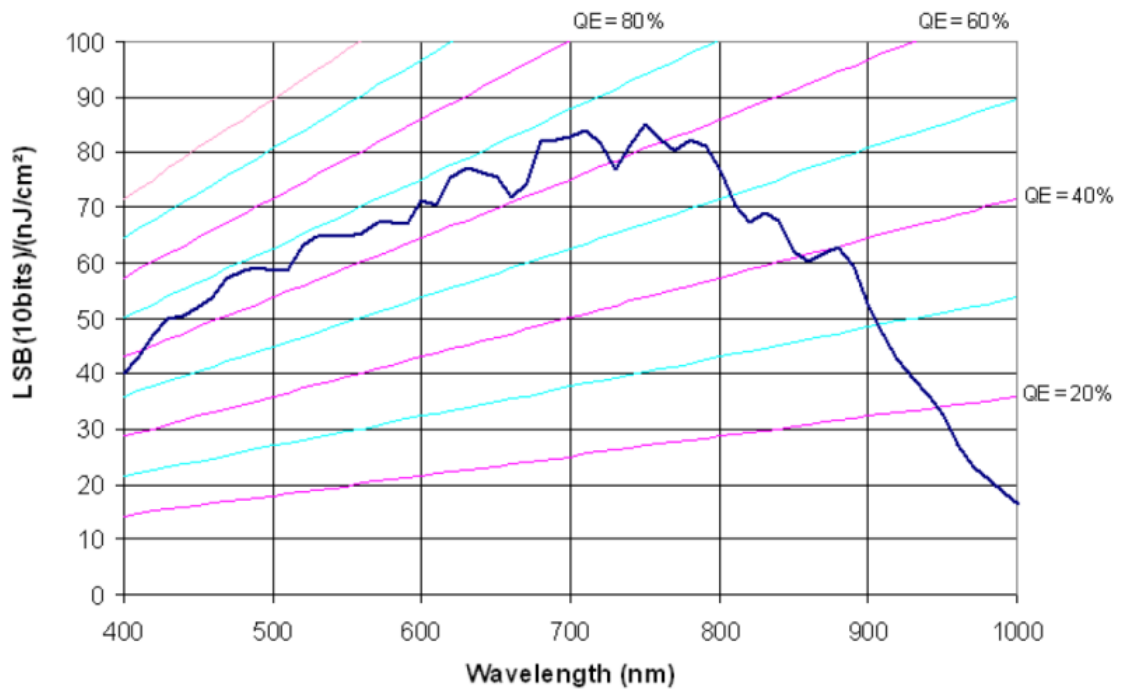

Figure 15: EV76C661 NIR

IC4203BU/CU

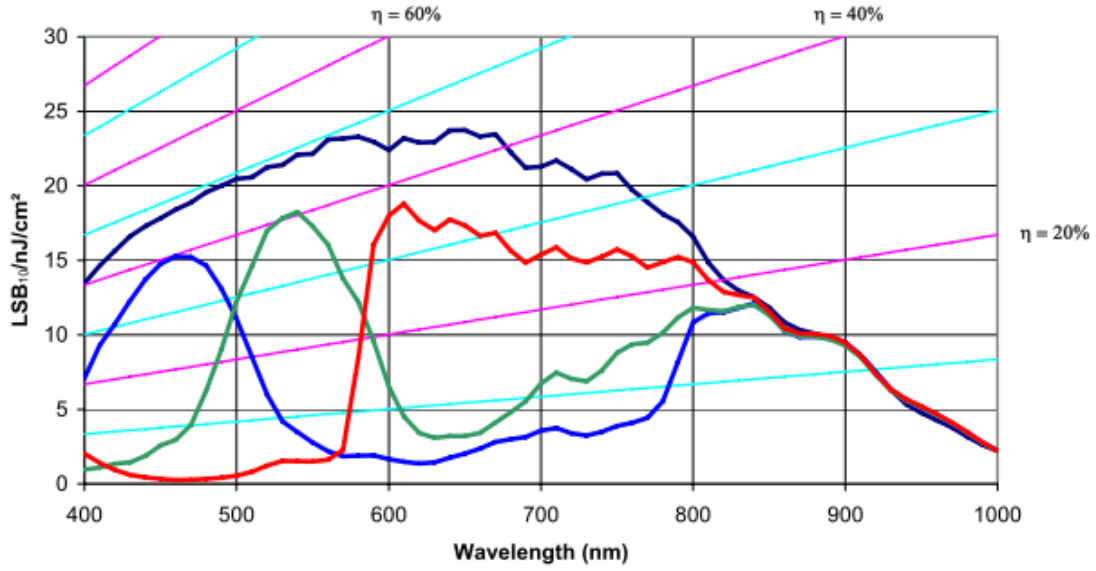

Figure 16: EV76C570 Color + BW

IC1300CU

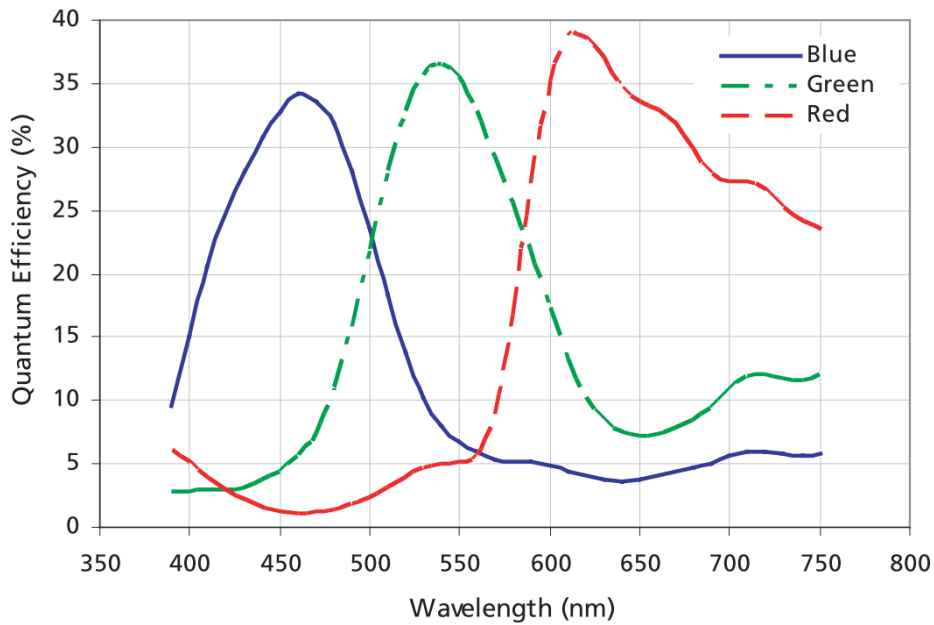

Figure 17: MT9T001 Color

IC1500BU

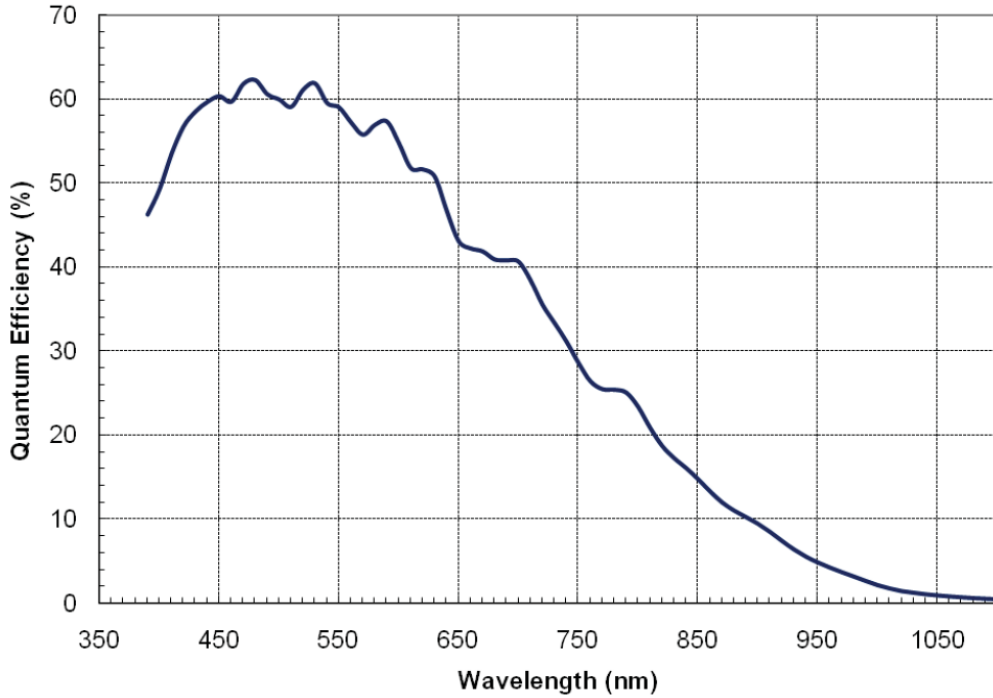

Figure 18: MT9P031 BW

IC1500CU

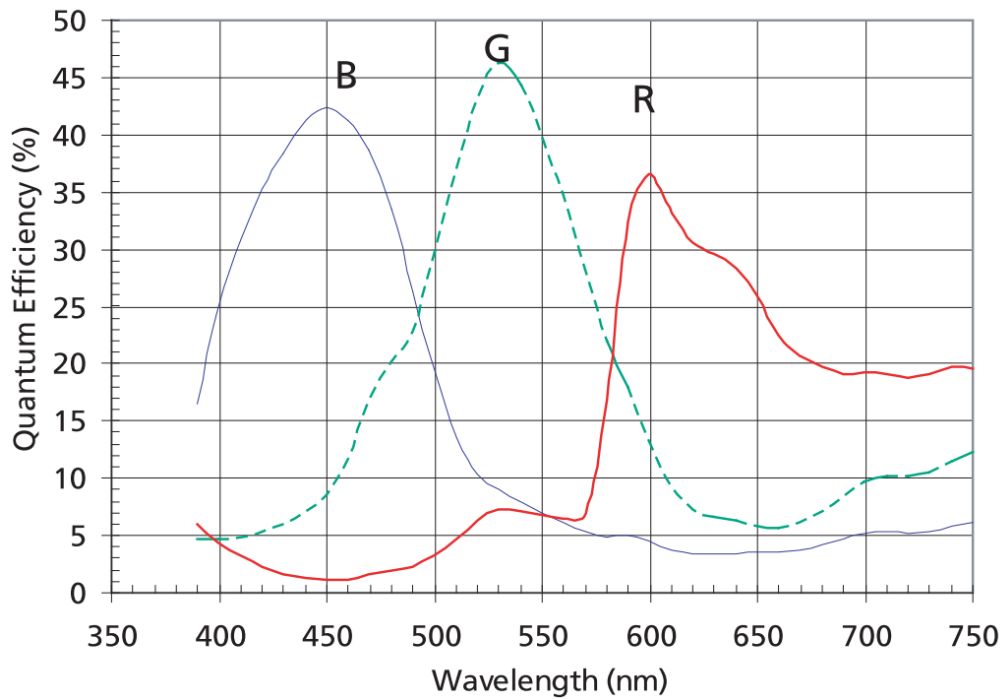

Figure 19: MT9P001 Color

IC11000BU

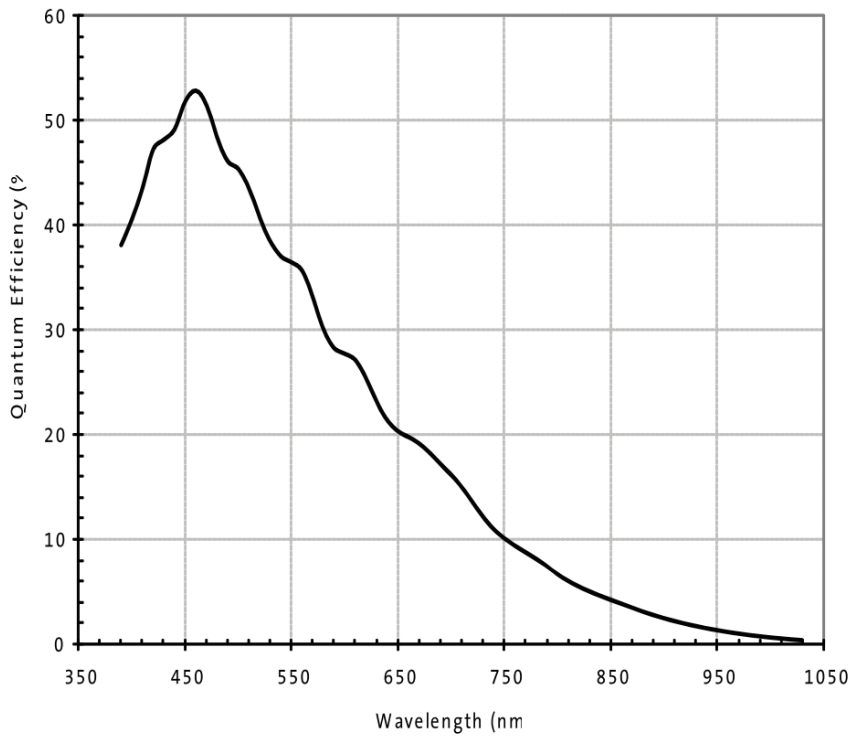

Figure 20: MT9J003 BW

IC11000CU

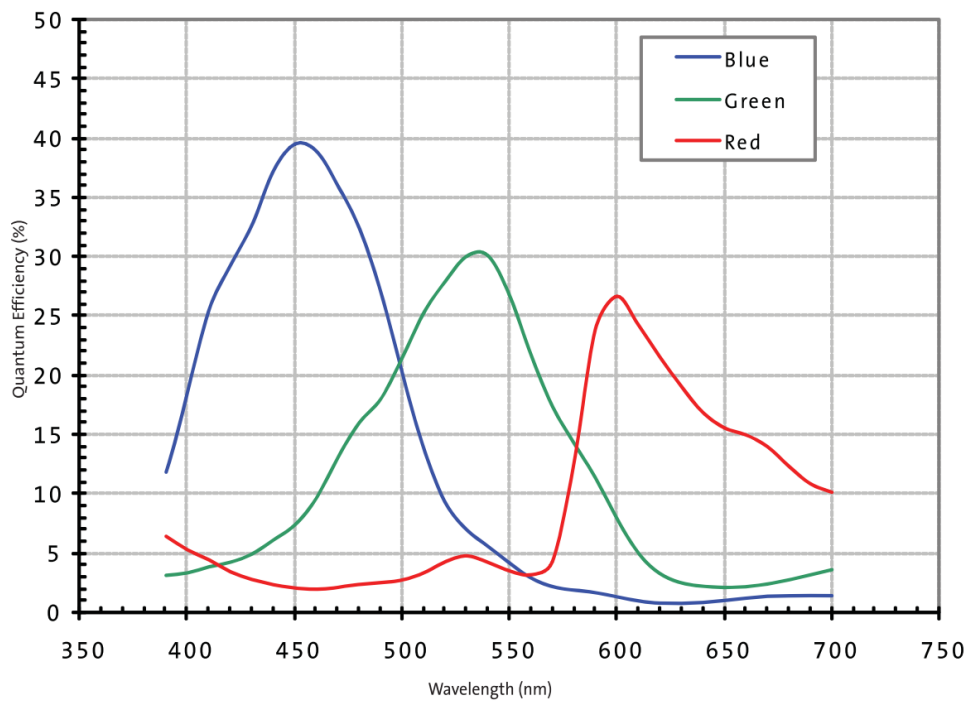

Figure 21: MT9J003 Color

Software

Software CD

The software CD includes the following directories:

WINDOWS

00_Documentation

3iCube Operation Manual
3iCube SDI API Manual

03_Driver

3iCube Camera Device Driver x32 / x64
3iCube Cognex AIK Setup

04_Viewer SW

iControl: (viewer Software)

05_Interfaces

DShow (additional COM-interface for DShow applications)
SDK
- 4133_MultiROI: (Microsoft Visual Studio multi roi example)
- C#: (C# SDK Example)
- C++: (Microsoft Visual Studio examples)
- C++Builder: (Borland C++ Builder SDK Example)
- iCubeSDKSample_x32_VC6: (Visual Studio 6.0 32bit SDK Example)
- iCubeSDKSample_x32_x64_vs2010: (Visual Studio 2010 32bit/64bit SDK Example)
- vb.6: (Visual Basic 6.0 SDK Example)
-VB.NET (VB.NET SDK Example)

06_Tools

dxRegistration:

Register more than one device as direct show -filter; fix positioning for direct show and SDK
(see readme.txt in this folder)

UnInstall_V10_ICUBE_Driver

3iCube driver uninstaller

LINUX

00_Documentation

3iCube Operation Manual
3iCube SDI API Manual

03_Driver

netusbcam_x.xx-1_i386_libudev.deb: (debian packet which uses libudev interface)
netusbcam_x.xx-1_i386_usbfs.deb: (debian packet which uses usbfs interface, used for older
debian distrutions)
readme.txt: (describes requirements of usbfs and libudev packets)
99-netusbcam.rules: (rules for netusbcam libudev packet)

05_Interfaces

SDK (SDK.tar.gz): (SDK packet)
API: (NETUSBCAM_API.h)
HelloICube: (minimal iCube example)
MultiROI_SIMR_Test: (multi roi sdk example)
MultiROITest (multi roi sdk example)
sdk_sample1: (QT based SDK example)

Software Installation (Windows)

Administrator rights are necessary for installing a driver

1. Copy the CD-Rom to your computer directory.
2. Plug in the USB 3.0 cable into your USB 3.0 port and 3iCube.
3. Windows plug and play manager recognizes the new hardware.
4. Follow the instruction of the Windows plug and play manager.
5. After the 3iCube driver is installed, you can see on the device Manager / imaging devices the recognized 3iCube camera.

3iCube: → NET ICube_Cam Device USB30

Windows (German version)

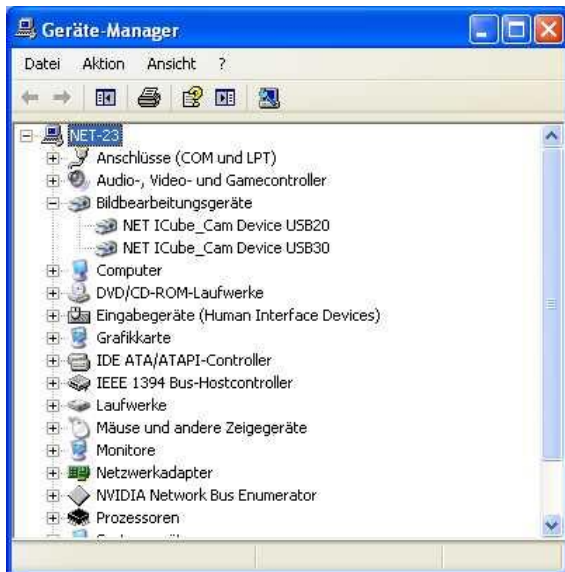

Windows (English version)

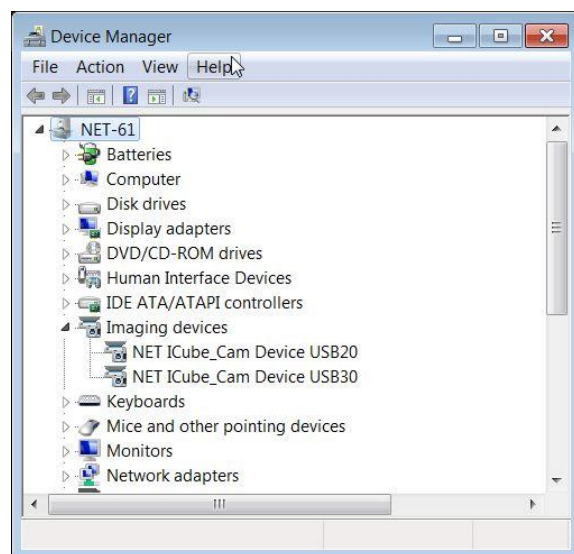

Figure 22: Device manager

Software and Driver update

The latest drivers and documentations are available on NET's homepage www.net-gmbh.com.

The software package includes following files:

- iControl viewer software
- USB driver
- API
- iCube Cognex AIK Setup

Please install the full package (iControl and USB driver) to get the right function.

After you have installed the full software package, you have to update the camera driver. If an 3iCube camera is connected to the PC, please update the camera-driver (new .inf file) on the device manager (imaging devices) and select the driver manually.

Problems

Due to heavy real-time data transfer and processing, system performance (especially CPU) is crucial for smooth operation. Possible performance degradation such as actual frame rate drop may occur for systems with lower performance than of Pentium IV 1.5 GHz computer. Faulty cables can drop the frame rate. The maximum of the bandwidth is defined by the USB chip set and the internal PC hardware.

If you can see following effects, please reduce the pixel clock of the 3iCube camera or disable the smart power management (CPU sleep states) of the PC:

Effects:

- Black image
- Bad frames
- Surge image
- No maximal frame rate

Applications

iCube iControl viewer software

The iControl software allows you to test the functionalities of the 3iCube camera on your own application. Apart from controlling the 3iCube camera, you can grab images and save them as jpg, bmp and tiff files.

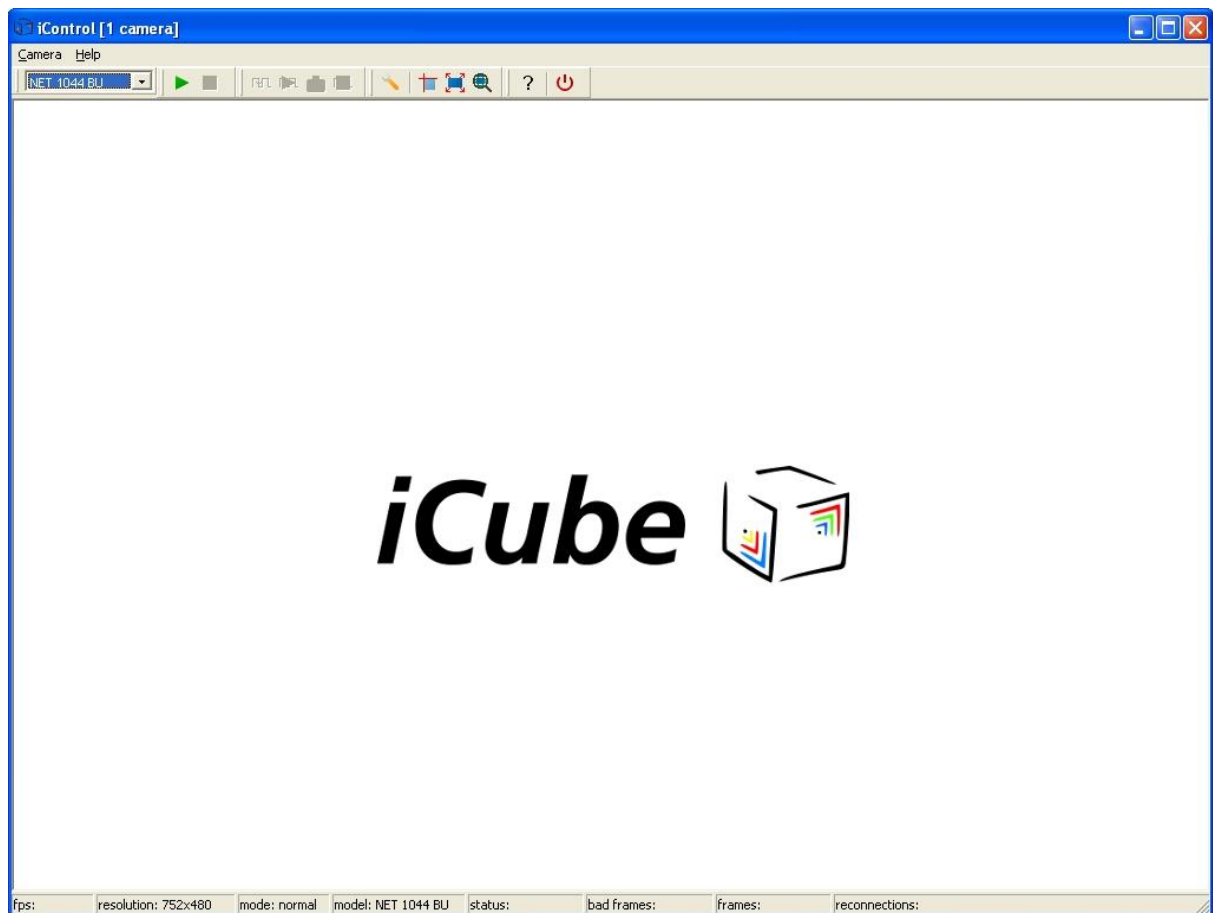

Figure 23: iControl viewer software

Calibration (optional)

The Color Calibration application uses a Macbeth standard color checker to evaluate the predefined color spots and calculate the correction values for the RGB color matrix in the camera.



Figure 24: Macbeth standard color checker

iCube dx-Registration

The 3iCube dx-Registration software is to register more than one device as dx-capture filter

The 3iCube dx-Registration software can be accessed as follows:

Connect all 3iCube cameras to PC.

- 1) Choose device to register. You will see the connected camera with serial numbers in the ComboBox. The selection of the dx-capture filter in 2) will change automatically, when changing the device.
- 2) Register the selected device. The name in the square brackets is the dx-friendly-name, which will appear in amcap for example. Additional functionalities are explained in `Tools\dxRegistration\readme.txt`

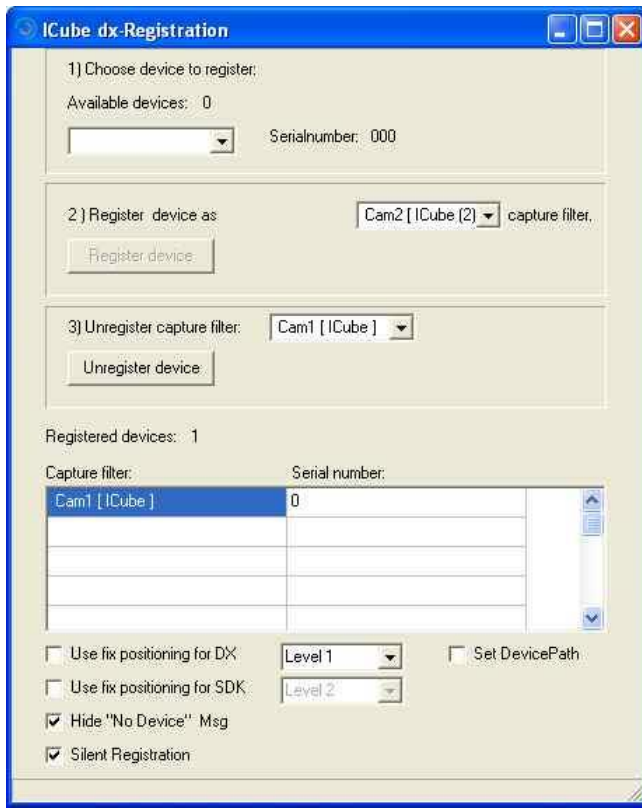

Figure 25: iCube dx registration

iCube SDK samples (Windows)

The **iCube** SDK samples shows, how you can develop or integrate the **3iCube** in your own application software.

On the CD-Rom you can find examples for following development software:

- 4133_MultiROI:

(Microsoft Visual Studio multi-roi example)

This example works with 4133 and 4203 cameras only.

The multi-roi offers two modes:

- MIMR (Multiple Integration Multiple ROI) mode allows the user to define an acquisition cycle comprising 1 to 4 ROI cycle(s).
- SIMR (Single Integration Multiple ROI) mode allows 1, 2 or 4 areas of interest to be acquired within the same integrated image.

- C++:

(Microsoft Visual Studio examples)

- C++Builder:

(Borland C++ Builder SDK Example)

- ICubeSDKSample_x32_VC6:

(Visual Studio 6.0 32bit SDK Example)

- ICubeSDKSample_x32_x64_vs2010:

(Visual Studio 2010 32bit/64bit SDK Example)

- VB.NET: (VB.NET SDK Example)
- C#: (C# SDK Example)
- vb.6.0: (Visual Basic 6.0 SDK Example)

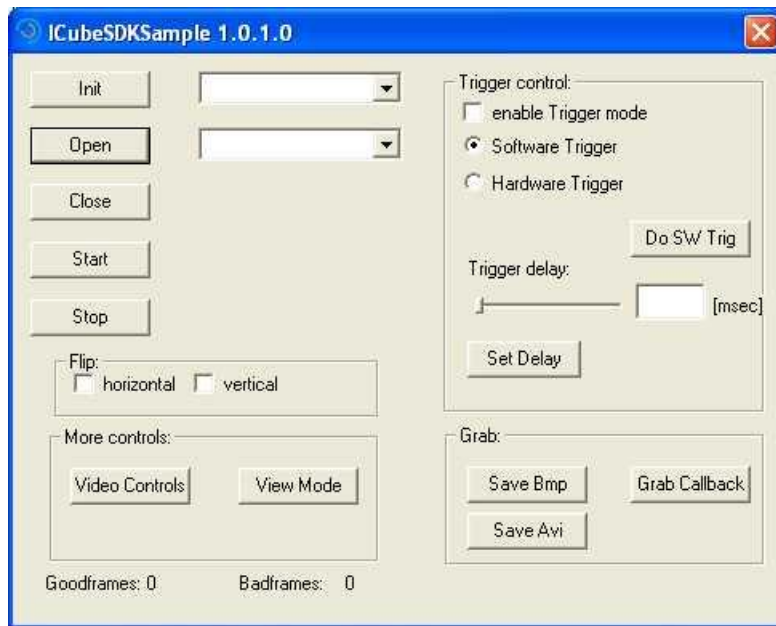

Figure 26: iCube SDK sample

Overview Standard Camera Functions

This section introduces standard functions of the cameras.

Table 10: Standard camera function control

Category	Function	Description
Camera control functions	iCube SDK Init	initializes the camera connected to your computer
	iCube SDK Open	opens the camera interface
	iCube SDK Close	closes the camera interface
	iCube SDK_IsOpen	checks for open camera interfaces
	iCube SDK_SetCallback	sets the callback function
	iCube SDK_Start	starts the video stream
	iCube SDK_IsStarted	checks for open image stream
	iCube SDK_Stop	stops the video stream
	iCube SDK_GetSize	get the current frame sizes
	iCube SDK_GetName	get the name of the selected camera
	iCube SDK_GetBrokenFrames	get the number of broken frames since the last start
	iCube SDK_GetGoodFrames	get the number of good frames since the last start
Version function	iCube SDK_GetVersion	get the SDK version
	iCube SDK_GetFWVersion	get the firmware version
	iCube SDK_GetSerialNum	get the serial number of the camera
	iCube SDK_GetFPGAVersion	get the camera fpga firmware version
ROI function	iCube SDK_SetResolution	set the resolution and position of the Region of Interest
	iCube SDK_GetResolution	get the resolution and position of the Region of Interest (ROI).
	iCube SDK_GetResolutionRange	get the min/max resolution of the Region of Interest (ROI)
	iCube SDK_SetResolutionParam	starts the image stream of roi 2-4 in multi roi applications

Mode function	iCube SDK_SetMode	the basic format (e.g. 640x480)
	iCube SDK_GetMode	get the basic format
	iCube SDK_GetModelist	get the possible formats of the camera
Bin Skip function	iCube SDK_SetBinSkip	set the camera into a skipping or binning mode
	iCube SDK_GetBinSkip	get the current skipping or binning mode
	iCube SDK_GetBinSkipList	get the possible skipping or binning formats of the camera
Save functions	iCube SDK_SaveToFile	saves a bitmap, jpg or tiff
	iCube SDK_SaveAVI	saves an avi stream to the hard disk
Trigger function	iCube SDK_SetTrigger	sets the Trigger mode
	iCube SDK_GetTrigger	gets the current trigger mode
Parameter functions	iCube SDK_SetCamParameter	set parameter value
	iCube SDK_GetCamParameter	get parameter value
	iCube SDK_GetCamParameterRange	get parameter min/max values, default value, auto, onepush and enabled information
Exposure functions	iCube SDK_SetExposure	set Exposure time (Input)
	iCube SDK_GetExposure	get Exposure time (Output)
	iCube SDK_GetExposureRange	get Exposure time Range (Output)
Color Transformation Control	iCube SDK_GetParamAuto	check, if the parameter supports auto mode
	iCube SDK_SetParamAuto	if auto mode is supported, set/unset auto mode of parameter
	iCube SDK_SetParamDef	set parameter to default setting
	iCube SDK_SetParamOnePush	if one push mode is supported, set/unset one push mode of parameter

Error Codes

Table 11: Error codes

Name	value	Description
IC_SUCCESS	0	no error
IC_ERROR	1	unspecified error
IC_IF_NOT_OPEN	-1	camera-interface is not open
IC_WRONG_PARAM	-2	parameter is out of range
IC_OUT_OF_MEMORY	-3	memory could not be allocated
IC_ALREADY_DONE	-4	e.g. Interface already open
IC_WRONG_CLOCK_VAL	-5	wrong PLL value (more information on operation manual / camera specification)
IC_COM_LIB_INIT	-6	wrong library called
IC_NOT_IF_STARTED	-7	parameter not usable when video stream is started
IC_WRONG_ROI_ID	-8	wrong roi id number
IC_IF_NOT_ENABLED	-9	parameter not enabled
IC_COLOR_CAM_ONLY	-10	parameter is only for color cameras
IC_DRIVER_VERSION	-11	version mismatch (*.sys is not compatible to *.dll)

DirectShow Interfaces

Supported standard-DirectShow-Interfaces

IID_IAMVideoProcAmp:

VideoProcAmp_Brightness

VideoProcAmp_Contrast

VideoProcAmp_Gamma

VideoProcAmp_Gain

IID_IAMVideoControl:

VideoControlFlag_FlipHorizontal

VideoControlFlag_FlipVertical

IID_IAMCameraControl:

CameraControl_Exposure

These are the interfaces for controlling camera parameters. Other implemented interfaces (e.g. IAMStreamConfig) are not shown here.

iCube DirectShow Interface

With the iCube-DirectShow-interface, it is possible to control all camera parameters, including Trigger-mode, ROI-mode and Bin/Skip-modes. (In DirectShow, ROI-mode is, unlike to the SDK, a basic format, like 640x480). For further documentation see DirectShow-SDK-Files (iCubeInterface.h,iCubeInterface.cpp).

iCube DirectShow setting

Video Control Parameters

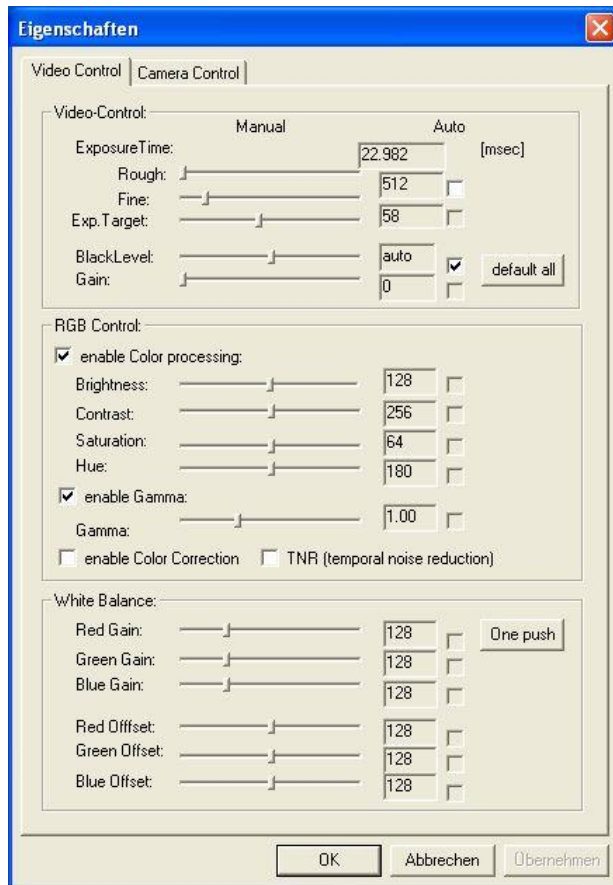

Figure 27: Video control parameters

Table 12: Video Control Parameters

Video Control	
Brightness	Eeprom
Contrast	Eeprom
Gamma	Eeprom
BlackLevel	Eeprom
BlackLevel Auto	Eeprom
Exposure Time	
Exposure Time Auto	Eeprom
Rough	Eeprom
Fine	Eeprom
Exp. Target	Eeprom
Gain	Eeprom
Default	Registry (default parameters)
Color Enhancement	
Color Enhancement enable	Eeprom
Saturation	Eeprom
White Balance	
White Balance	Eeprom
Red	Eeprom
Green	Eeprom
Blue	Eeprom
Red Offset	Eeprom
Green Offset	Eeprom
Blue Offset	Eeprom
One Push	not saved
Color correction enable	Eeprom
TNR enable	Eeprom

Camera Control Parameters

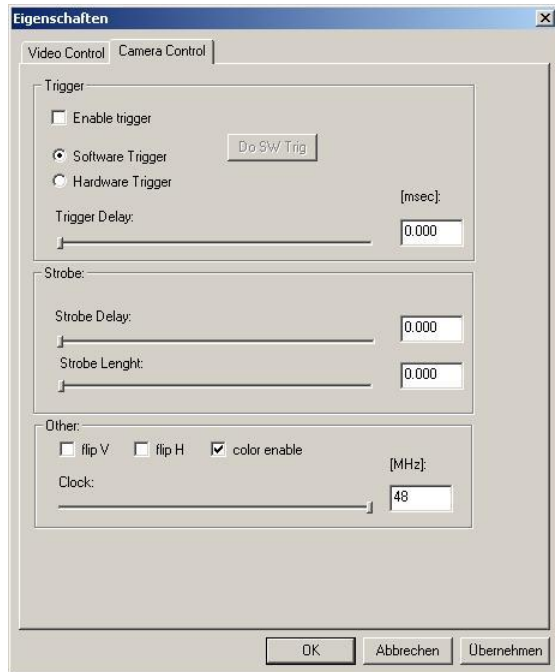

Figure 28: Camera control parameters

Table 13: Camera Control Parameters

Trigger	
Trigger enable	not saved
Software Trigger	not saved
Hardware Trigger	not saved
Trigger Delay	Eeprom
Push SW trigger	not saved
Strobe	
Strobe Delay	Eeprom
Strobe Length	Eeprom
Other	
flip V	Registry
flip H	Registry
color enable	Registry /RAW Data on/off
Clock	Registry

Video Stream Control Parameters

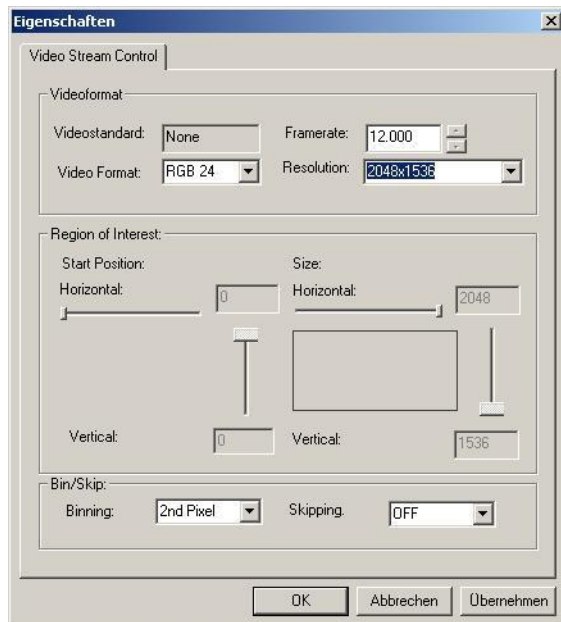

Figure 29: Video stream control parameters

Table 14: Video stream control parameters

Videoformat	
Videostandard	display only
Video Format	Registry
Framerate	calculation (PLL, H, Shutter)
Resolution	Registry
Region of Interest	
Start Position	
Horizontal	Registry
Vertical	Registry
Size	
Horizontal	Registry
Vertical	Registry
Bin/Skip	
Binning	Registry
Skipping	Registry

Technical Support

NET ensures the conformity of its product to be reliable and free from defects during manufacturing by testing all the cameras before release. However, unexpected problems and technical issues may come up due to the complexity of the product.



TEL: 02-2585-8592

FAX: 02-2598-8802

E-MAIL: sales.tp@fadracer.com

WEBSITE: www.fadracer.com